



Mortice locks and cylinders

Locks

Multipoint locks

Keying

Cylinders

Locks	4
Multipoint locks	9
Keying	14
Cylinders	16



Locks

D031L

Latch Lock

Stainless Steel

Stainless Steel

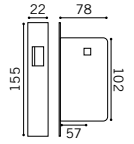

D032D

Bathroom Deadlock

Stainless Steel

Stainless Steel

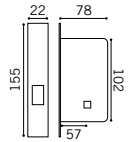

D033D

Multiple Lever Deadlock

Stainless Steel

Stainless Steel

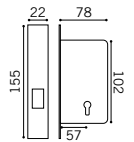

Locks

D034S

Multiple Lever Sash Lock

Stainless Steel. PVD

Stainless Steel
PVD

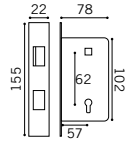

D035S

Bathroom Sash Lock

Stainless Steel

Stainless Steel

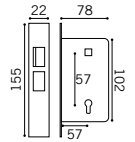

D036S

Cylinder Sash Lock

Stainless Steel. PVD

Stainless Steel
PVD

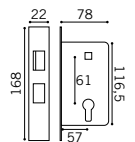

Locks

D037D

Cylinder Deadlock

Stainless Steel

Stainless Steel

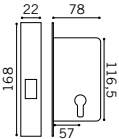

D072EC

Cylinder Sash Lock

Stainless Steel

Stainless Steel

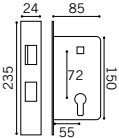

D0175E

Cylinder Emergency Exit Lock

Stainless Steel

Stainless Steel

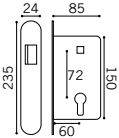

Locks

DMWC-SS-008

Bathroom Deadlock

Stainless Steel

Stainless Steel

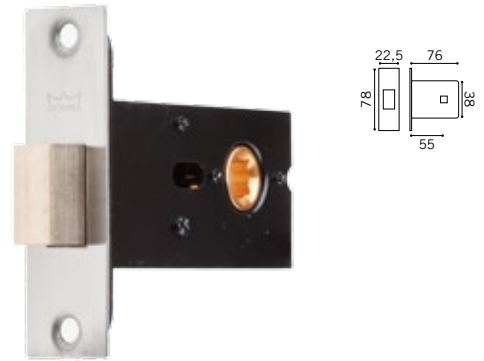

REBATE KITS

Nickel Plated. Brass

D038R for D036S, D037D

D039R for D033D, D034S

D072EC REBT for D072EC



D07625 (D07635)

Narrow Stile Heavy Duty Swivel Sash Lock

Stainless Steel

25mm Backset

35mm Backset

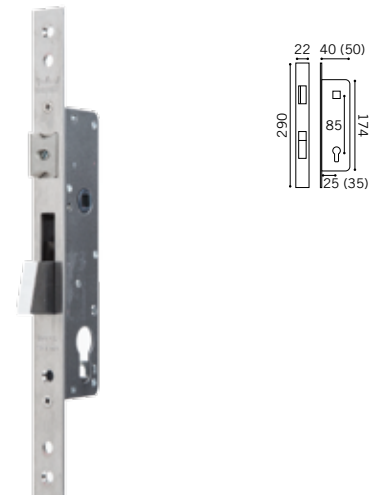

Locks

D07725 (D07735)

Narrow Stile Heavy Duty Swivel Dead Lock

Stainless Steel

- 25mm Backset
- 35mm Backset

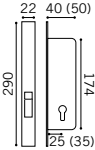

D07925 (D07935)

Narrow Stile Heavy Duty Roller Dead Lock

Stainless Steel

- 25mm Backset
- 35mm Backset

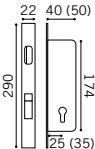

Multipoint locking systems

MEETING HIGH SECURITY REQUIREMENTS

DORMAKABA MULTIPOINT LOCKING SYSTEMS

Whether it's your family, home or office – security is essential. dormakaba multipoint locking systems provide protection against intruders with high-quality primary lateral locks. These systems also help protect against excessive noise and energy wastage as the additional locking points keep the door particularly tight against its seal.

Further optional advantages of dormakaba multipoint locking systems

- Automatic locking function
- Combination with electronic access control possible
- For single or double-leaf doors
- Deadlocking with 20mm deadbolt projection
- All components integrated in the door for easy installation and maintenance
- Rotating bolts and centre bolt of steel; centre bolt projections from 20mm to 27mm

Series/Feature	810	840	830	820
Electronic Locking				•
Electronic Unlocking				•
Mechanical Locking	•	•		
Mechanical Unlocking	•	•	•	
Automatic Locking			•	•



Multipoint locking systems

MULTIPOINT LOCK WITH DEADBOLTS

810 SERIES MULTIPOINT LOCKING SYSTEMS

Features

Lateral locking: sliding deadbolts.

Central lock; 85 mm centre; operation with europrofile cylinder.

Throw: 20 mm; Follower: 8 mm.

The latch can be replaced by roller or cap.

The lock is equipped with a wheel-cam stopping device if the cylinder is not fitted inside the lock case.

Accessories required

Strike plates.

Optional: Roller Kits. Electric strike.

Backsets available: 35, 40mm.



Multipoint locking systems

MULTIPOINT LOCK WITH ROTATING DEADBOLTS

840 SERIES MULTIPOINT LOCKING SYSTEMS

Features

3 rotating deadbolts with anti-drill/anti-cut cover plates in carbonitrided steel.

Central lock; centre distance 92 mm; for operation with europrofile cylinder.

Throw: 27 mm; Follower 8 mm.

Reversible and adjustable latch which can be replaced by roller or cap for deadlocking only.

Latch bolt/roller operated by key or handle.

2 nylon end blocks for U-version.

Accessories required

Strike plates.

Optional: Electric strike. Roller kit.

Backsets available: 35, 40mm.



Multipoint locking systems

MULTIPOINT LOCK WITH AUTOMATIC LOCKING

830 SERIES MULTIPOINT LOCKING SYSTEMS

Features

Automatic locking of latch, 3 deadbolts and rotating hook bolts.

Central lock; centre distance 92 mm; for operation with europrofile cylinder

Right or left latch, non reversible.

Deadbolts and latch operated by key or handle.

Throw: 27 mm with anti-drill and anti-cut cover plates in carbo-nitrided steel.

2 nylon end blocks for U-version.

Accessories required:

Strike plates.

Optional: Electric strike

Confirm handing (LH/RH). Backsets available: 35, 40mm.



Multipoint locking systems

ELECTROMECHANICAL MULTIPOINT LOCK

820 SERIES MULTIPOINT LOCKING SYSTEMS

Features

Automatic locking of latch, 3 deadbolts and rotating hook bolts; 12V D.C.
Central lock; centre distance 92mm; for operation with europrofile cylinder.
Right or left latch, non reversible.
Deadbolts and latch operated by key, handle or motor.
Throw: 27 mm with anti-drill and anti-cut cover plates in carbo-nitrided steel.
Connection cable, 2 nylon end blocks for U-version.

Accessories required

Strike plates.

Power supply.

Optional: Electric strike.

Confirm handing (LH/RH). Backsets available: 35, 40mm.



Keying systems

MASTER KEYING SYSTEMS

DORMA's Master Keying Systems provide the most extensive access security solutions, customisable for large facilities to smaller solutions for niche customer profiles. The various typologies of master keying systems are as illustrated.

KEY TO DIFFER (KD)

Each cylinder can be opened by its own key.

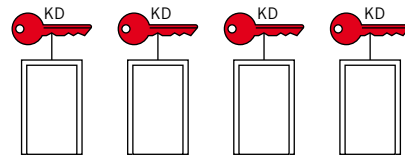

KEYED ALIKE (KA)

Several cylinders with the same coding can be opened by the same key.

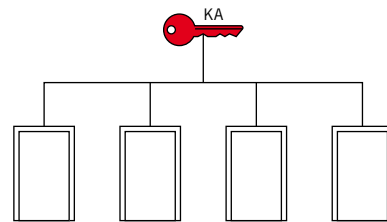

COMMON LOCK SYSTEM (CL)

Each key opens only its own cylinder and a central lock cylinder (e.g. the common entrance to an apartment block).

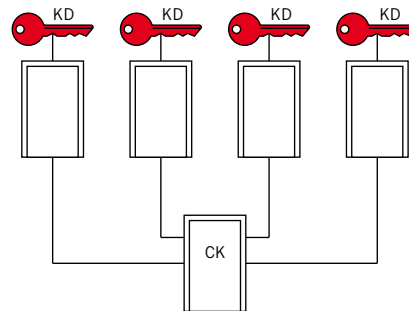

MASTER KEY SYSTEM (MK)

Each cylinder is opened by its own individual key and by the Master Key.

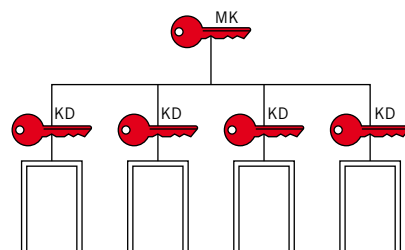

Keying systems

GRANDMASTER KEY SYSTEM (GMK)

Each cylinder is opened by its own individual key and the grandmaster key. A master key can be coded to open specific groups of cylinders.

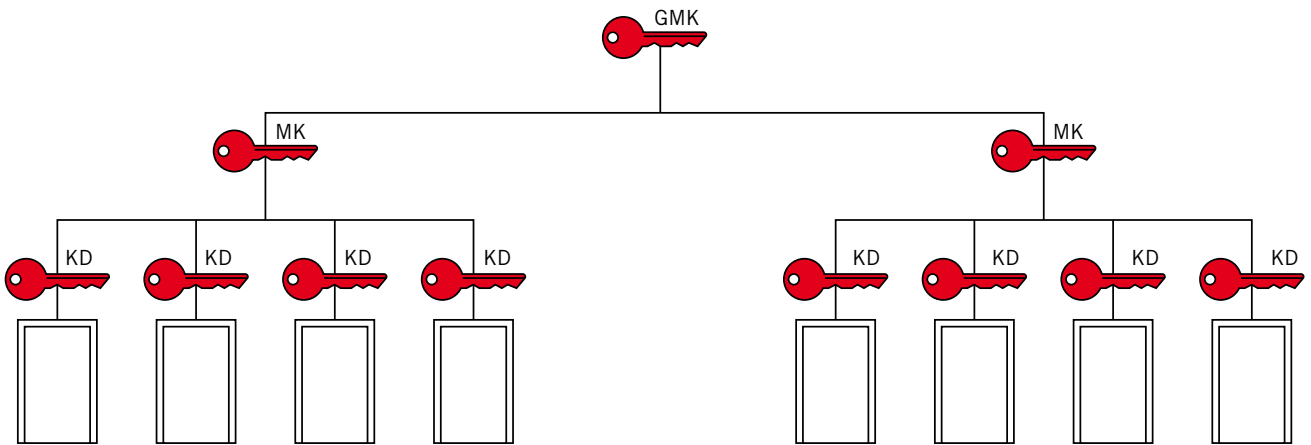

COMPLEX MASTER KEY SYSTEM (GGMK)

Individual keys or master keys belonging to different groups of cylinders can open one or more cylinders belonging to other groups and can be extended to the Great Grandmaster Key system (GGMK).

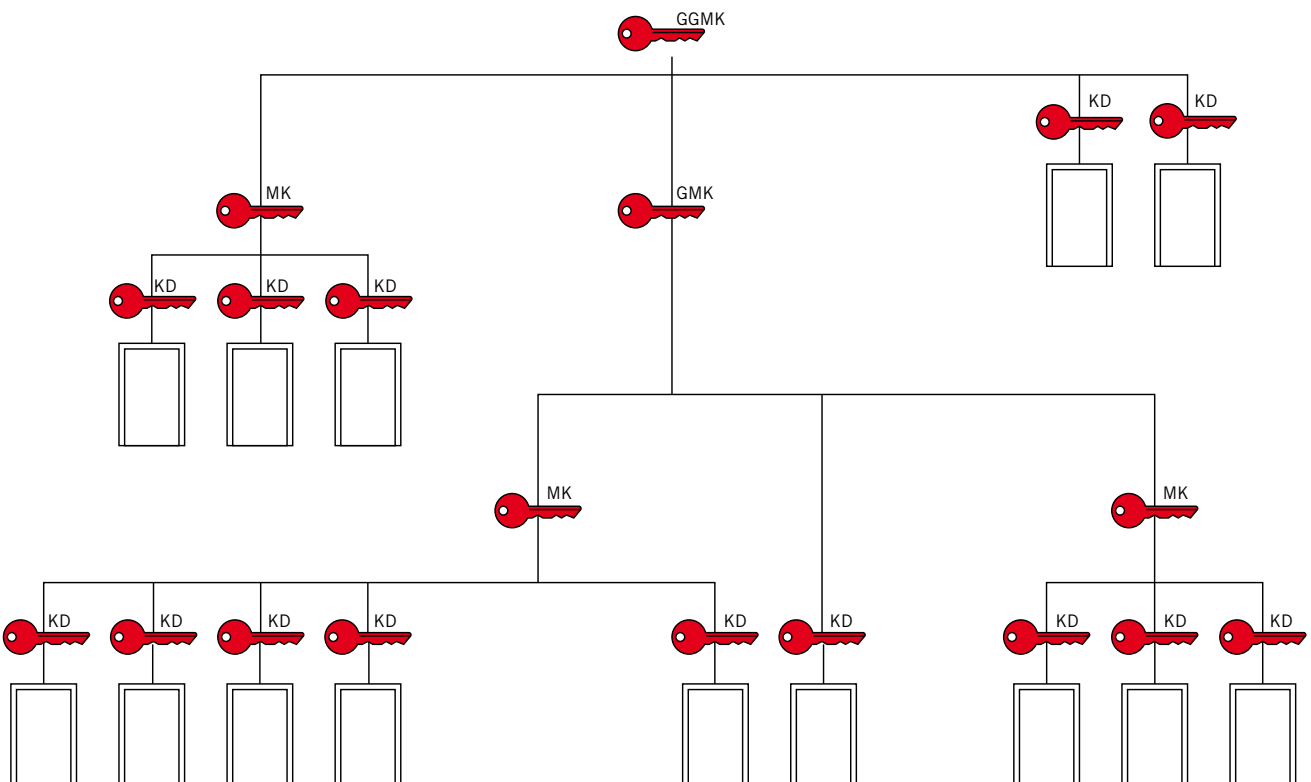

Cylinders

DOUBLE CYLINDER

Master Keyed

Brass. Satin Nickel

DDC106600 MK 66mm Brass

DDC106601 MK 66mm Satin Nickel

Brass. Satin Nickel GMK



56 60 70 80 90 100mm lengths available. KA GMK GGMK and Construction Key available

KNOB CYLINDER

Master Keyed

Brass. Satin Nickel

DKC106600 66mm Brass

DKC106601 66mm Satin Nickel

Brass. Satin Nickel GMK



56 60 70 80 90 100mm lengths available. KA GMK GGMK and Construction Key available

SINGLE CYLINDER

Master Keyed

Brass. Satin Nickel

DSC104300 43mm Brass

DSC104301 43mm Satin Nickel

Brass. Satin Nickel GMK



40 45mm lengths available. KA GMK GGMK and Construction Key available

DOUBLE CYLINDER

Keyed to Differ

Brass. Satin Nickel

DDC056000 60mm Brass

DDC056001 60mm Satin Nickel

DDC056500 65mm Brass

DDC056501 65mm Satin Nickel



Cylinders

KNOB CYLINDER

Keyed to Differ

Brass. Satin Nickel

DKC056500 65mm Brass

DKC056501 65mm Satin Nickel



SINGLE CYLINDER

Keyed to Differ

Brass. Satin Nickel

DSC054200 43mm Brass

DSC054201 43mm Satin Nickel



PRIVACY CYLINDER

Brass. Satin Nickel

DBC006000 60mm Brass

DBC006001 60mm Satin Nickel

DBC006600 66mm Brass

DBC006601 66mm Satin Nickel



HALF KNOB CYLINDER

Brass. Satin Nickel

DHK004000 40mm Brass

DHK004301 40mm Satin Nickel



45mm length available

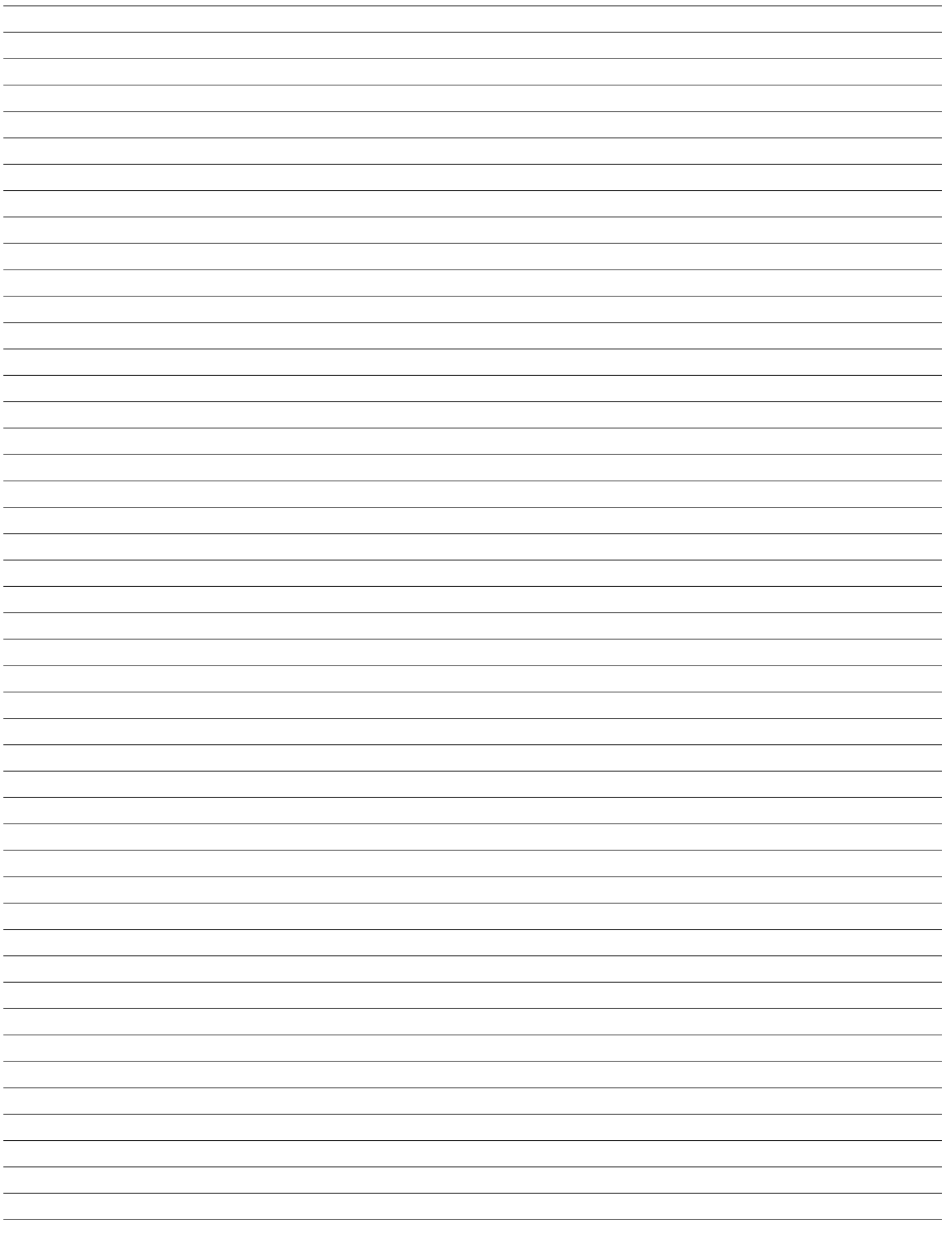

Catalogue

HEAD OFFICE
2 Gravel Drive
Kya Sands Business Park
Kya Sands
2169
011 510 1500
086 694 2794
info.za@dormakaba.com

www.dormakaba.com